



# PRODUCT SPECIFICATION

**Model No:CSD-S20240G/S20241G**

## Descriptions:

- 0.2 Inch Dual Digit SMD Display
- Emitting Color : Yellow Green



CUSTOMER APPROVED SIGNATURES	APPROVED BY	CHECKED BY	PREPARED BY

**CHINA SEMICONDUCTOR CORPORATION**  
Address:2FL. NO.909,Chung-Cheng Road,  
Chung-Ho City Taipei Hsien,Taiwan.

**OPTO PLUS TECHNOLOGIES CO.,LTD**  
Address:696 Shun jiang Rd.,Ji Shan St.Shaoxing,  
ZheJiang,China

Tel:886-2-2223-9696  
Fax:886-2-2223-9377

Tel:86-0575-88623888  
Fax:86-0575-88623112



**Model No: CSD-S20240/S20241G**

**Features -**

1. 0.2 inch (5.08mm) digit height.
2. Qualified according to JEDEC moisture sensitivity Level 2a.
3. RoHS compliant.
4. Low power consumption.
5. Easy mounting on P.C. board.

**Device Selection Guide -**

Model No.	Chip		Description
	Material	Emitting Color	
<b>CSD-S20240G</b>	<b>GaP</b>	<b>Yellow Green</b>	<b>Common Anode</b>
<b>CSD-S20241G</b>	<b>GaP</b>	<b>Yellow Green</b>	<b>Common Cathode</b>

**Mechanical Dimensions -**

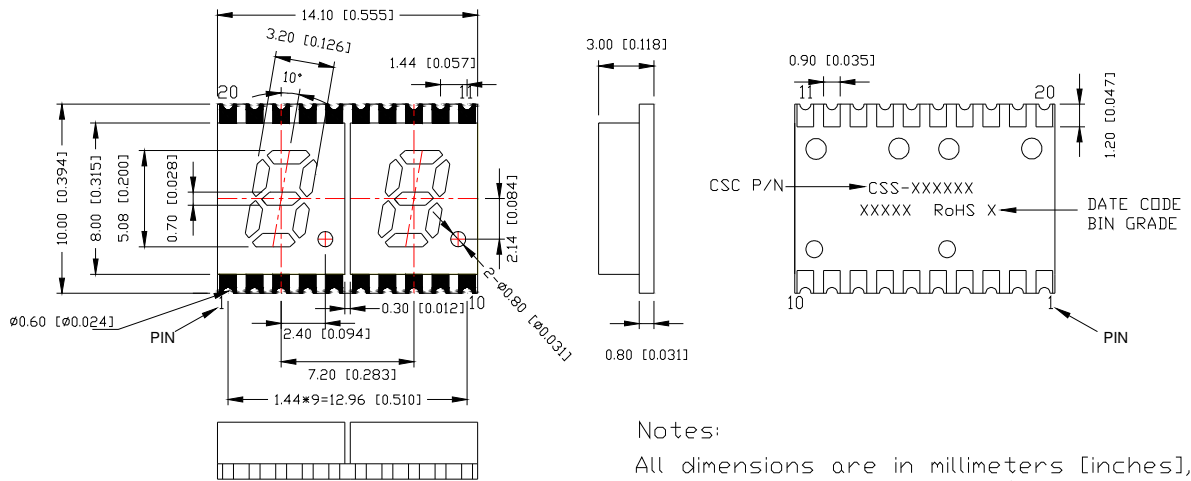

**Notes:**

All dimensions are in millimeters [inches], and tolerance is  $\pm 0.25$  [0.010] unless otherwise noted.



Model No: CSD-S20240/S20241G

Internal Circuit Diagrams -

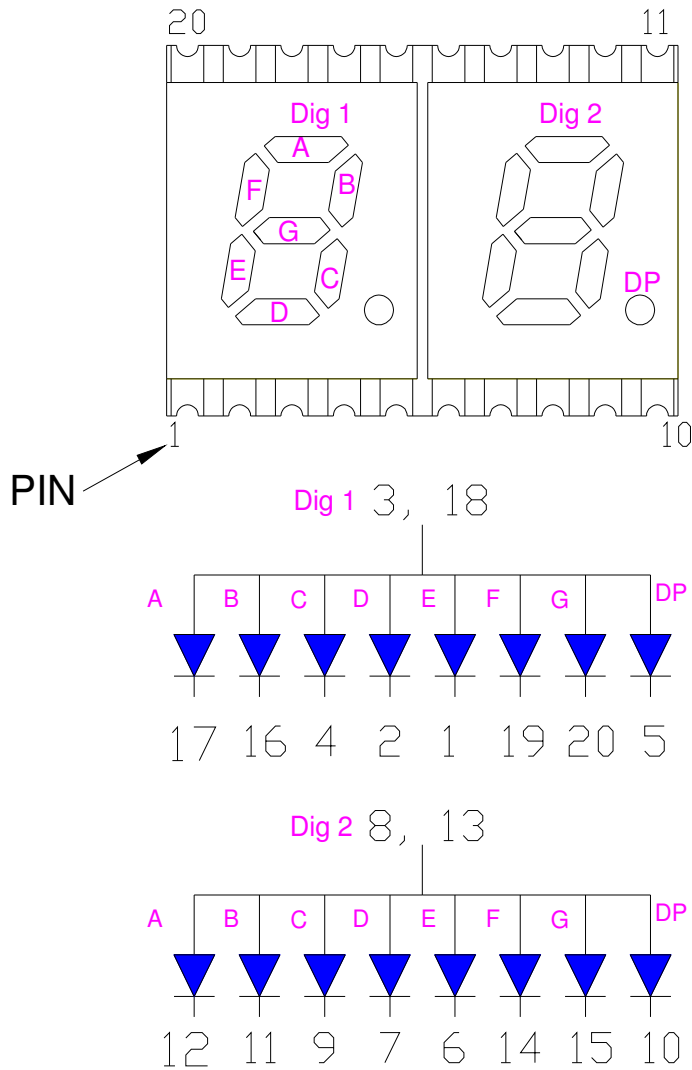

CSD-S20240 Common Anode  
(CSD-S20241 Common Cathode)



Model No: CSD-S20240/S20241G

■ Absolute Maximum Rating -

(Ta=25°C)

Parameter	Symbol	Rating	Unit
Power Dissipation Per Dice	P <sub>AD</sub>	70	mW
Continuous Forward Current Per Dice	I <sub>AF</sub>	25	mA
Peak Current Per Dice(duty cycle 1/10,1KHz)	I <sub>PF</sub>	90	mA
Derating Linear From 25°C Per Dice	-	0.33	mA/°C
Reverse Voltage Per Dice	V <sub>R</sub>	5	V
Operating Temp.	T <sub>opr</sub>	-40 ~ +105	°C
Storage Temp.	T <sub>stg</sub>	-40 ~ +105	°C

Note:Solder temperature 1/16 inch below seating plane for 3 seconds at 260°C

■ Electro-optical Characteristics -

(Ta=25°C)

Parameter	Symbol	Min.	Typ.	Max.	Unit	Condition
Forward Voltage Per Segment	V <sub>F</sub>	-	2.1	2.8	V	I <sub>F</sub> =20mA
Luminous Intensity Per Segment	I <sub>v</sub>	1000	2500	-	ucd	I <sub>F</sub> =10mA
Peak Emission Wavelength	λ <sub>P</sub>	-	570	-	nm	I <sub>F</sub> =20mA
Spectrum Radiation Bandwidth	Δλ	-	30	-	nm	I <sub>F</sub> =20mA
Reverse Current	I <sub>R</sub>	-	-	100	μA	V <sub>R</sub> =5V
Luminous Intensity Matching Ratio	I <sub>V-m</sub>	-	-	2:1	-	I <sub>F</sub> =10mA



**Model No: CSD-S20240/S20241G**

**Typical Electrical / Optical Characteristics Curves -**

**(Ta = 25°C Unless Otherwise Noted)**

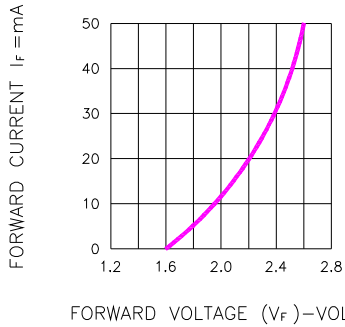

Fig.1 FORWARD CURRENT VS. FORWARD VOLTAGE

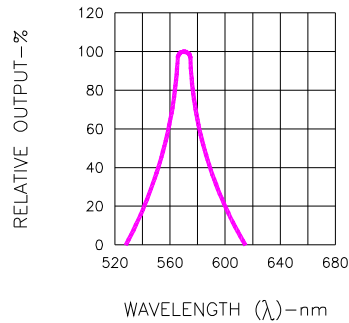

Fig.2 SPECTRAL RESPONSE

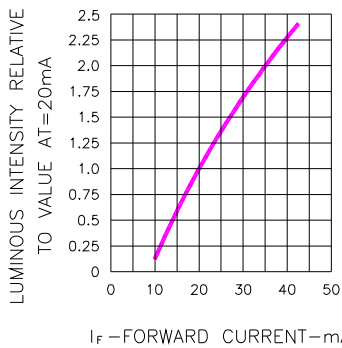

Fig.3 RELATIVE LUMINOUS INTENSITY VS. FORWARD CURRENT

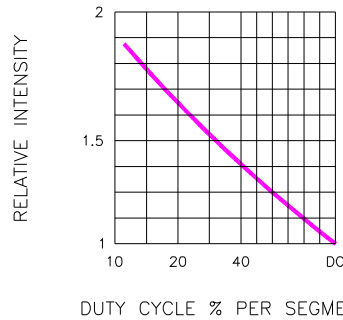

Fig.5 LUMINOUS INTENSITY VS. DUTY CYCLE

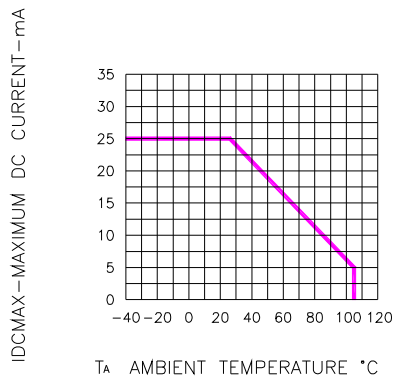

Fig.4 MAXIMUM ALLOWABLE DC CURRENT PER SEGMENT VS. A FUNCTION OF AMBIENT TEMPERATURE

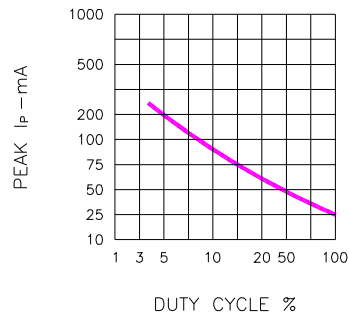

Fig.6 MAX PEAK CURRENT VS. DUTY CYCLE % (REFRESH RATE f=1 KHz)



Model No: CSD-S20240/S20241G

## SMT REFLOW SOLDERING INSTRUCTIONS

### IR Reflow Temperature / Time :

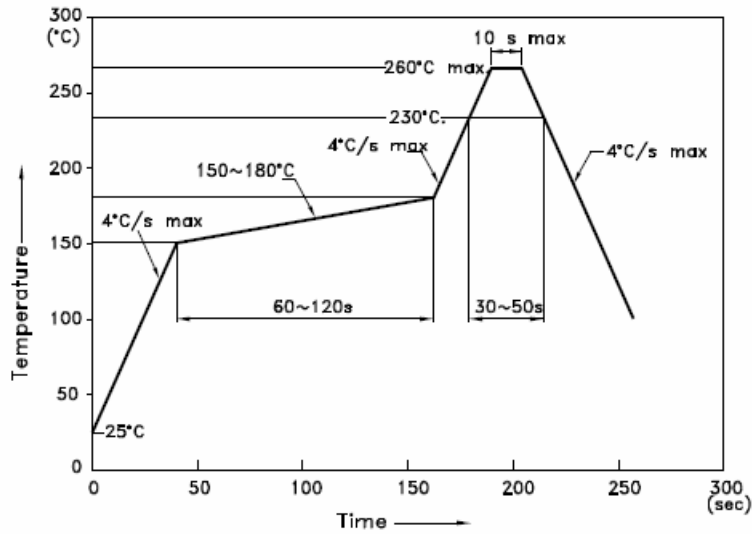

#### NOTES:

1. We recommend the reflow temperature 245°C(+/-5°C). The maximum soldering temperature should be limited to 260°C.
2. Don't cause stress to the epoxy resin while it is exposed to high temperature.
3. Number of reflow process shall be 2 times or less.

### Soldering Pad Size

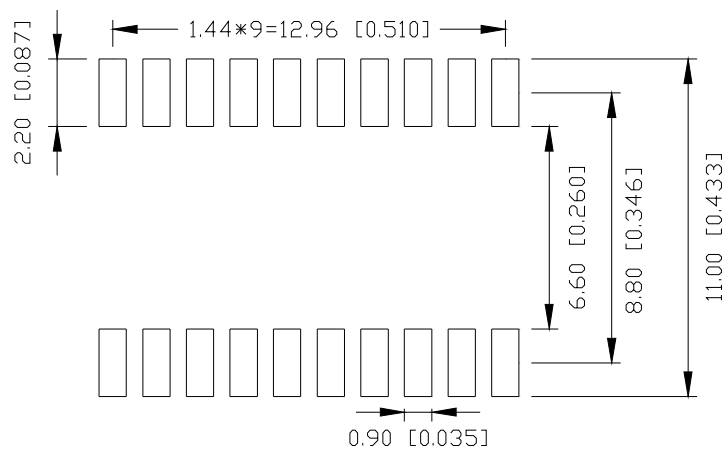



Model No: CSD-S20240/S20241G

REEL DIMENSIONS

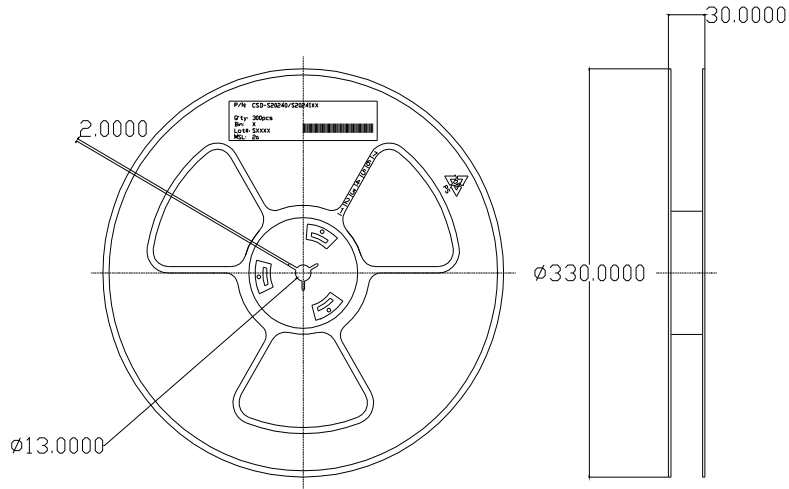

PACKING & LABEL SPECIFICATIONS

